



NOBLE[®]
WIRE & TERMINAL CORP.
SPRINGFIELD, OREGON



“WE HAVE IT!” ■ “WE WILL SHIP TODAY” ■ “WE ARE NOT JUST OUT!”



**MAIN PLANT & NATIONAL HEADQUARTERS
1620 32ND STREET
SPRINGFIELD, OREGON 97478-5529**

**DUN & BRADSTREET RATING AAA-1
STARTED 1977**

**It is Often Said
You Cannot Please All of the People
All of the Time.**

**That May Be True, but
at Noble
We Really Try**



NOBLE[®]
WIRE & TERMINAL CORP.
SPRINGFIELD, OREGON

CONTENTS

BATTERY STARTER CABLE	14 & 23	LUGS BRAZED BARREL HD	23
BATTERY TERMINALS & ACCESSORIES	17, 18 & 19	MULTI CONDUCTOR WIRE & CABLE	14
CHASSIS CLIPS	19	PACKAGING	27 & 28
CLAMPS	13	POINT OF PURCHASE DISPLAYS	29-34
CONNECTORS & TERMINALS WITH HEAT SHRINK	22	PRIMARY WIRE & CODE	15 & 16
CROSSLINK WIRE	16	SPI-WRAP	11
FUSES	23	SPLIT LOOM & ACCESSORIES	12
FUSE HOLDERS & TERMINAL BLOCKS	20 & 24	TERMINALS & CONNECTORS 22-10 AWG	3-11
FUSIBLE LINK WIRE	16	TEST CLIPS & CLAMPS	19 & 20
GROMMETS	13	TESTERS & TEST LEADS	21
HEAT SHRINK TUBING	16	TIE WRAPS & MOUNTS	12
HIGH TEMPERATURE TERMINALS	21	TOOLS	16 & 24
IGNITION TERMINALS	19	TRAILER CONNECTORS	18 & 19
KITS & KIT RACKS	25 & 26	UNDER WATER SPLICE KITS	22
LARGE TERMINALS & CONNECTORS 8-4/0 AWG	11	VACUUM CAPS	19
LIGHT ACCESSORIES & SWITCHES	21	WP SERIES PINS, TOWERS & SHROUDS	24

Noble Assures You...

The very top quality in the terminal and wire industry. Our terminals feature pure soft copper for easy crimping, electroplating to protect against corrosion, long barrel design for quick, more secure crimping. Our terminals meet or exceed UL & CSA standards where possible.

Our insulated series tongue-type terminals feature the smooth entry barrel. Never a wire hang-up, a barrel full of insulation, or an out-of-round barrel that just squashes instead of crimping.

Yes, we have supreme quality so that your customer may have the best.

Packaging for Everyone...

Tiny mini-packs with 1 to 4 pieces for the do-it-yourselfer. Packages of 1,000 pieces and several size packages in between.





























Part Numbers and Ordering...

The number of pieces per pack are listed on the price sheet. Order by the package.

- All one-price Mini-Packs are identified by **(M)** after the part number. Order five packs at a time.
- All Thrifty Packs are identified by **(D)** after the part number. Order one or more at a time.
- All Half-Packs are identified by **(H)** after the part number. Order one or more at a time.
- All Regular Packs are identified by the part number. Order one or more at a time.
- All Bulk Packs are identified by **(B)** after the part number. Order one or more at a time.

TERMINALS

22-18 WIRE SIZE











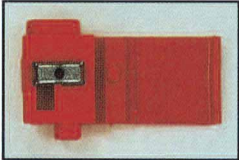
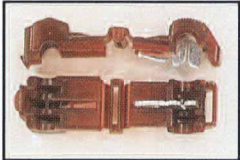





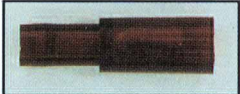

	PART NO.		PART NO.		PART NO.	STUD SIZE
BUTT CONNECTORS FLARED VINYL INSULATION		SOLID OR BRAZED SEAM BARREL NYLON INS.		UNINSULATED		
	11		S-11		U-11	
	210		S-210		U-210	4
	211		S-211		U-211	6
RING TONGUE TERMINALS		FLARED NYLON INS. WITH SLEEVE				
	212		S-212		U-212	8
	213		S-213		U-213	10
	214		S-214		U-214	1/4"
	215		S-215		U-215	5/16"
	216		S-216		U-216	3/8"
SPADE TONGUE TERMINALS						
	311		S-311		U-311	6
	312		S-312		U-312	8
	313		S-313		U-313	10
BLOCK SPADES						
	340		S-340		U-340	4
	341		S-341		U-341	6
	342		S-342		U-342	8
	343		S-343		U-343	10
FLANGED BLOCK SPADES						
	346		S-346		U-346	6
	347		S-347		U-347	8
	348		S-348		U-348	10
HOOK TONGUE TERMINALS						
	411		S-411		U-411	6
	412		S-412		U-412	8
	413		S-413		U-413	10
QUICK CONNECTS MALE						
	501		S-505*		U-501	.110x.020
	505		S-511		U-505	.187x.032
	511				U-511	.250x.032
FEMALE						
	502		S-506*		U-502	.110x.020
	506		S-512		U-506	.187x.032
	512				U-512	.250x.032
FULLY INSULATED MALE		MALE		PIGGYBACK		
	507		S-507		513	.187x.020
	515		S-515			.250x.032
FEMALE		FEMALE				
	504		S-508			.110x.020
	508		S-516			.187x.020
	516					.250x.032

Uninsulated terminals with brazed seam are available. To order, preface the part number with BU.
The price is the same as the flared vinyl insulated terminals.

* .020 tab thickness



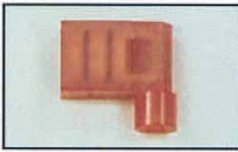





















TERMINALS

22-18 WIRE SIZE

	PART NO.		PART NO.		PART NO.	STUD SIZE
QUICK SPLICE						
	558		519	22-18 GA. T-TAP USE WITH 515 MALE CONNECTOR		
PIN TERMINAL .080 DIAMETER						
	610					
BULLET						
	611		S-611		U-611	.157
RECEPTACLE						
	616		S-616			.157
THREE-WAY & FOUR-WAY CONNECTORS						
	614		S-614		U-614	
	615		S-615		U-615	
KNIFE CONNECTOR						
	714					
FLAG TERMINALS #8 STUD						
	772				792	.187X.020
	782				798	.250X.032
FUSE BLOCK TERMINAL						
	812					

TERMINALS

16-14 WIRE SIZE

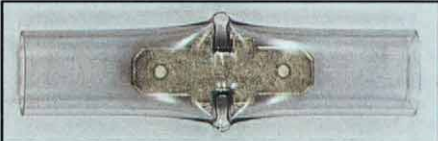









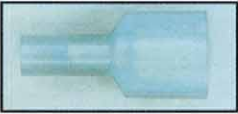
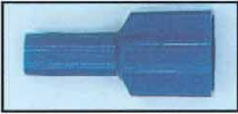















	PART NO.		PART NO.		PART NO.	STUD SIZE
BUTT CONNECTORS FLARED VINYL INSULATION		SOLID OR BRAZED SEAM BARREL NYLON INS.		UNINSULATED		
	12		S-12		U-12	
RING TONGUE TERMINALS		FLARED NYLON INS. WITH SLEEVE				
	220 221 222 223 224 225 226		S-220 S-221 S-222 S-223 S-224 S-225 S-226		U-220 U-221 U-222 U-223 U-224 U-225 U-226	4 6 8 10 1/4" 5/16" 3/8"
SPADE TONGUE TERMINALS						
	321 322 323		S-321 S-322 S-323		U-321 U-322 U-323	6 8 10
BLOCK SPADES						
	350 351 352 353		S-350 S-351 S-352 S-353		U-350 U-351 U-352 U-353	4 6 8 10
FLANGED BLOCK SPADES						
	356 357 358		S-356 S-357 S-358		U-356 U-357 U-358	6 8 10
HOOK TONGUE TERMINALS						
	421 422 423		S-421 S-422 S-423		U-421 U-422 U-423	6 8 10
QUICK CONNECTS MALE						
	509 529 521		S-509 S-529* S-521		U-509 U-529 U-521	.110x.020 .187x.032 .250x.032
FEMALE						
	510 530 522		S-510 S-530* S-522		U-510 U-530 U-522	.110x.020 .187x.032 .250x.032
PIGGY BACK	523					.250x.032
						.250x.032
DOUBLE MALE RECEPTACLE	524					.250x.032

Uninsulated terminals with brazed seam are available. To order, preface the part number with BU. The price is the same as the flared vinyl insulated terminals.

* .020 tab thickness











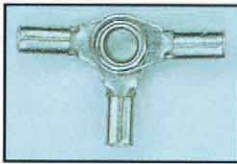

TERMINALS

16-14 WIRE SIZE

	PART NO.		PART NO.		PART NO.	STUD SIZE
FULLY INSULATED QUICK CONNECT MALE		FLARED NYLON INS. WITH SLEEVE				
	517 525		S-517 S-525			.187x.020 .250x.032
FEMALE						
	514 518 526		S-514 S-518 S-526			.110x.020 .187x.020 .250x.032
QUICK SPLICE WITH .157 RECEPTACLE		QUICK SPLICE				
	528		527		520	
Both wires go through						16-14 GA. T-TAP USE WITH 525 MALE CONNECTOR
	557	18-12 AWG LONG MALE				
			552	SHELL FOR 552		
FEMALE WITH TAB		SHELL FOR 550				
	550		551		553	.250 .250
PIN TERMINAL .080 DIAMETER		22-14 AWG 2 OR 3 WIRE PIGTAIL CONNECTOR WITH SEALANT				
	620		554	5/16" FEMALE WITH TAB		
BULLET TERMINALS					560	.312
	621		S-621			FITS SEALED BEAM LAMPS 18-12 AWG.
	622		S-622		U-621	.157
BULLET RECEPTACLES					U-622	.176
	623 633					.157 .176
	626		S-626			.157
	627		S-627			.176





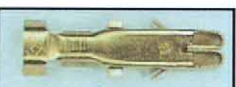





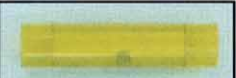











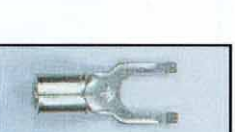
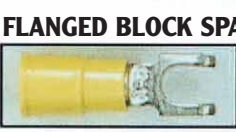



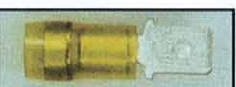

TERMINALS

16-14 WIRE SIZE

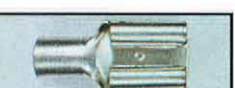
	PART NO.		PART NO.		PART NO.	STUD SIZE	
3-WAY & 4-WAY CONNECTORS							
FLARED VINYL INSULATION		FLARED NYLON INS. WITH SLEEVES		UNINSULATED			
	624		S-624		U-624		
	625		S-625		U-625		
	721	CLOSED END CONNECTORS (PIGTAIL)					
	724	KNIFE CONNECTOR					
FLAG TERMINALS							
	776					10	
	786					10	
	796					.250x.032	
	799					.250x.032	
FUSE BLOCK TERMINAL							
	822						

TERMINALS











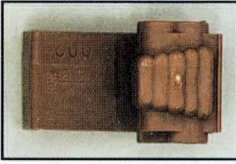
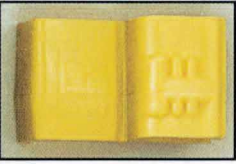
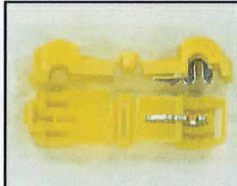

12-10 WIRE SIZE





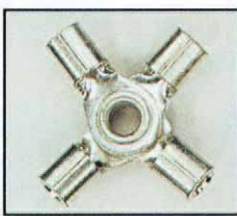
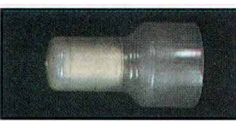

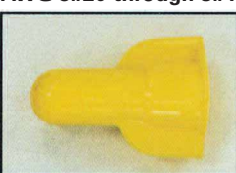
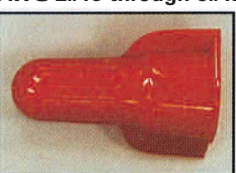

	PART NO.		PART NO.	PART NO.	STUD SIZE
BUTT CONNECTORS FLARED VINYL INSULATION	13	SOLID OR BRAZED SEAM BARREL NYLON INS.	S-13	UNINSULATED	U-13
					
RING TONGUE TERMINALS	231 232 233 234 235 236 237	FLARED NYLON INS. WITH SLEEVE	S-231 S-232 S-233 S-234 S-235 S-236 S-237		U-231 U-232 U-233 U-234 U-235 U-236 U-237
					6 8 10 1/4 5/16" 3/8" 1/2"
SPADE TONGUE TERMINALS	331 332 333		S-331 S-332 S-333		U-331 U-332 U-333
					6 8 10
BLOCK SPADES	361 362 363		S-361 S-362 S-363		U-361 U-362 U-363
					6 8 10
FLANGED BLOCK SPADES	366 367 368		S-366 S-367 S-368		U-366 U-367 U-368
					6 8 10
HOOK TONGUE TERMINALS	431 432 433		S-431 S-432 S-433		U-431 U-432 U-433
					6 8 10
QUICK CONNECTS (SLIP-ONS) MALE	531		S-531		U-531
					.250x.032
FEMALE	532		S-532		U-532
					.250x.032
FEMALE	534		S-534		U-534
					.375x.050
FULLY INSULATED MALE	535	MALE	S-535		.250x.032
					
FEMALE	536	FEMALE	S-536	PIGGYBACK	533
					.250x.032
					.250x.032

Uninsulated terminals with brazed seam are available. To order, preface the part number with BU. The price is the same as the flared vinyl insulated terminals.

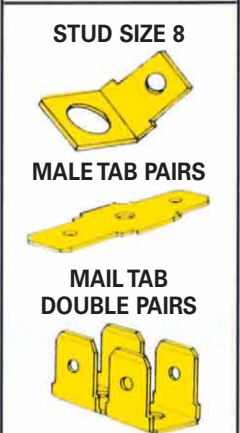
TERMINALS

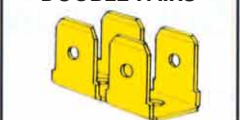

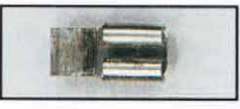
12-10 WIRE SIZE

	PART NO.		PART NO.		PART NO.	STUD SIZE
QUICK CONNECTS						
 12-10 MAIN WIRE 14-16 TAP-IN	537	 12-10 MAIN WIRE 12-10 TAP-IN	538	 12-10 GA. T-TAP USE WITH 535 MALE CONNECTOR	539	
PIN TERMINAL .110 DIAMETER						
	630					
BULLET						
	631		S-631			.157
THREE-WAY AND FOUR-WAY CONNECTORS						
	634		S-634		U-634	
	635		S-635		U-635	
CLOSED END CONNECTOR (PIGTAIL)				KNIFE CONNECTOR 12-10 AWG		
	731				734	
TWIST CONNECTORS AWG 3#20 through 3#12		AWG 2#18 through 5#12		FLAG TERMINAL		
	706		708		790	.250x.032

	PART NO.	DEGREE	TAB SIZE
.250 MALE TABS			
	741	DOUBLE MALE SINGLE FEMALE FLAT	.250
	742	DOUBLE MALE SINGLE FEMALE CHAIR	.250
	743	PIGGYBACK FEMALE WITH MALE TAB	.250
	744	FUSE CLIP TAB	.250
	740	MINI FUSE CLIP TAB	.187
	745	ATO/ATC FUSE CLIP TAB	.250
STUD SIZE 8			
	747	FLAT	.250
	748	30°	.250
	749	45°	.250
	750	60°	.250
	751	90°	.250
	752	FLAT	.250
	754	45°	.250
	756	90°	.250
MAIL TAB DOUBLE PAIRS			
	757	FLAT	.250
	759	45°	.250
	761	90°	.250
FLAG TERMINALS 12-10 WIRE SIZE			
	779		10
	789		10
	797		.250
FUSE BLOCK TERMINAL			
	832		



INSULATED BUTT CONNECTORS

SOLID OR BRAZED BARREL

	PART NO.	WIRE SIZE
	14	8 GA.
	15	6 GA.
	16	4 GA.

INSULATED RING LUGS

BRAZED BARREL

	WIRE SIZE	STUD SIZE	PART NO.
	8 GA.	10	243
	8 GA.	1/4"	244
	8 GA.	5/16"	245
	8 GA.	3/8"	246
	8 GA.	1/2"	247
	6 GA.	10	253
	6 GA.	1/4"	254
	6 GA.	5/16"	255
	6 GA.	3/8"	256
	6 GA.	1/2"	257
	4 GA.	10	263
	4 GA.	1/4"	264
	4 GA.	5/16"	265
	4 GA.	3/8"	266
	4 GA.	1/2"	267

HEAVY DUTY

BUTT CONNECTORS

SOLID OR BRAZED SEAM BARREL

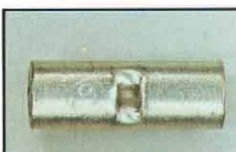
	PART NO.	WIRE SIZE
	910	8 GA.
	916	6 GA.
	922	4 GA.
	928	2 GA.
	934	1/0
	939	2/0
	944	3/0
	950	4/0

TUBULAR COPPER LUGS

	PART NO.	WIRE SIZE	STUD SIZE
	911	8 GA.	10
	912	8 GA.	1/4"
	913	8 GA.	5/16"
	914	8 GA.	3/8"
	915	8 GA.	1/2"
	917	6 GA.	10
	918	6 GA.	1/4"
	919	6 GA.	5/16"
	920	6 GA.	3/8"
	921	6 GA.	1/2"
	923	4 GA.	10
	924	4 GA.	1/4"
	925	4 GA.	5/16"
	926	4 GA.	3/8"
	927	4 GA.	1/2"
	929	2 GA.	10
	930	2 GA.	1/4"
	931	2 GA.	5/16"
	932	2 GA.	3/8"
	933	2 GA.	1/2"
	935	1/0 GA.	1/4"
	936	1/0 GA.	5/16"
	937	1/0 GA.	3/8"
	938	1/0 GA.	1/2"
	940	2/0 GA.	1/4"
	941	2/0 GA.	5/16"
	942	2/0 GA.	3/8"
	943	2/0 GA.	1/2"
	945	3/0 GA.	1/4"
	946	3/0 GA.	5/16"
	947	3/0 GA.	3/8"
	948	3/0 GA.	1/2"
	951	4/0 GA.	1/4"
	952	4/0 GA.	5/16"
953	4/0 GA.	3/8"	
954	4/0 GA.	1/2"	

Brazed Barrel
uninsulated lugs are
shown on page 22.



SUPER LUGS

1/0 and larger.



3/8" and 1/2" stud only.

Preface part # w/SL. Example: 2/0 1/2" stud=SL-943.

PROTECTIVE INSULATION

SPI-WRAP

FOR WIRE CABLES OR OIL AND AIR LINES
IN NATURAL OR BLACK IN 100' COILS

	PART NO.	SIZE
	0002	1/8"
	0003	3/16"
	0004	1/4"
	0005	3/8"
	0006	1/2"
	0008	3/4"
	0010	1"
	0052	1/8"
	0053	3/16"
	0054	1/4"
	0055	3/8"
	0056	1/2"
	0058	3/4"
	0060	1"

WHITE

BLACK

SPLIT LOOM & ACCESSORIES

SPLIT LOOM



100' ROLLS

Also available in packed short lengths. See price list.

PART NO.	FITS
0121-2C	1/4" ID
0123-2C	3/8" ID
0125-2C	1/2" ID
0129-2C	3/4" ID
0130-2C	1" ID
0135-2C	1-1/2" ID

CLIP WITH WINGS



SIZE	PART NO.	FITS
3/8"	0030	0123
1/2"	0050	0125
3/4"	0090	0129

END FITTING



PART NO.	FITS
0500	1/2"

OUTLETS

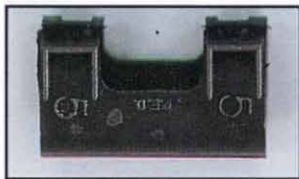

PART NO.	FITS
0550	1/2"

TEES



PART NO.	L	R	C
0333	3/8"	3/8"	3/8"
0555	1/2"	1/2"	1/2"
0993	3/4"	3/4"	3/8"
0995	3/4"	3/4"	1/2"

NYLON TIE WRAPS

NATURAL & BLACK

PART NO.	LENGTH	COLOR	STRENGTH	BNDL.DIA.
----------	--------	-------	----------	-----------



1003	3"	Natural	18 lbs.	3/4"
1053	3"	Black	18 lbs.	3/4"
1004	4"	Natural	30 lbs.	1"
1054	4"	Black	30 lbs.	1"
1006	6-1/2"	Natural	50 lbs.	1-3/4"
1056	6-1/2"	Black	50 lbs.	1-3/4"
1011	11"	Natural	50 lbs.	3"
1061	11"	Black	50 lbs.	3"
1014	14"	Natural	50 lbs.	4"
1064	14"	Black	50 lbs.	4"
1016	14"	Natural	120 lbs.	4"
1066	14"	Black	120 lbs.	4"
1021	24"	Natural	175 lbs.	7"
1071	24"	Black	175 lbs.	7"
1027	36"	Natural	175 lbs.	9"
1077	36"	Black	175 lbs.	9"

MOUNTING HEAD TIES



1007	6-1/2"	Natural	50 lbs.	1-3/4"
1057	6-1/2"	Black	50 lbs.	1-3/4"
1015	14"	Natural	50 lbs.	4"
1065	14"	Black	50 lbs.	4"
1024	14"	Natural	120 lbs.	4"
1074	14"	Black	120 lbs.	4"

4" 30 lb.- 6-1/2" & 11" 50 lb. ties are available in colors. See price sheet for details.

ADHESIVE-BACKED TIE MOUNT

PART NO.	SIZE
1031	3/4"
1032	1"



TWIST LOCK

1047



VINYL GROMMETS

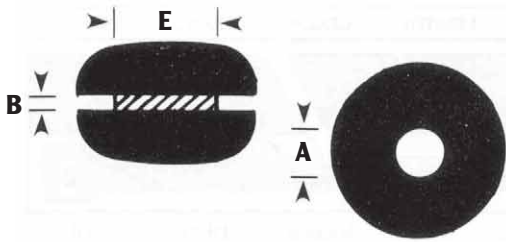

B	E	A	PART NO.
1/16"	1/4"	1/8"	1121
1/16"	5/16"	3/16"	1122
1/16"	3/8"	1/4"	1123
1/16"	7/16"	5/16"	1124
1/16"	1/2"	3/8"	1125
1/16"	5/8"	1/2"	1126
1/8"	21/32"	25/64"	1127
1/16"	7/8"	5/8"	1128
1/16"	1"	11/16"	1129
1/8"	1-3/8"	1"	1132

NYLON FLEXIBLE GROMMETING

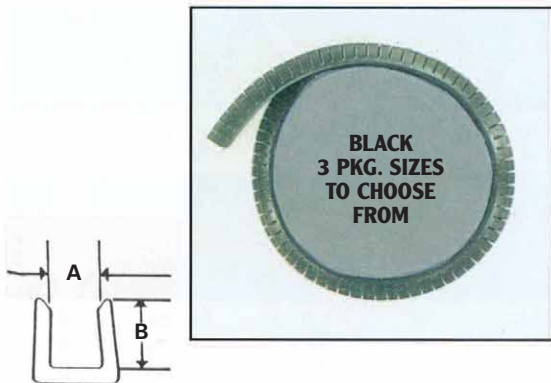

LENGTH PER PACK	A	B	PART NO.
1-Pc. 24"	.040	.150	1550-2A
1-Pc. 100'	.040	.150	1550-2C
1-Pc. 10'	.040	.150	1500-2P
1-Pc. 24"	.052	.150	1552-2A
1-Pc. 100'	.052	.150	1552-2C
1-Pc. 10'	.052	.150	1552-2P
1-Pc. 24"	.085	.155	1554-2A
1-Pc. 100'	.085	.155	1554-2C
1-Pc. 10'	.085	.155	1554-2P
1-Pc. 24"	.125	.175	1556-2A
1-Pc. 100'	.125	.175	1556-2C
1-Pc. 10'	.125	.175	1556-2P
1-Pc. 24"	.187	.222	1558-2A
1-Pc. 100'	.187	.222	1558-2C
1-Pc. 10'	.187	.222	1558-2P
1-Pc. 24"	.250	.230	1560-2A
1-Pc. 100'	.250	.230	1560-2C
1-Pc. 10'	.250	.230	1560-2P

INSULATED CLAMPS

1/4" MOUNTING HOLE NEOPRENE INSULATION

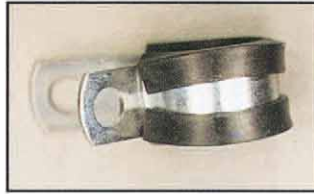

I.D. CLOSED	PART NO.
1/4"	2114
3/8"	2115
1/2"	2116
5/8"	2117
3/4"	2118
7/8"	2119
1"	2120
1-1/2"	2124

3/8" MOUNTING HOLE VINYL INSULATION



1/4"	2214
3/8"	2215
1/2"	2216
5/8"	2217
3/4"	2218
7/8"	2219
1"	2220
1-1/2"	2224
2"	2228
2-1/2"	2232
3"	2236

ADHESIVE MOUNT CLAMP



3/16"	2513
1/4"	2514
3/8"	2515
1/2"	2516
3/4"	2518
1"	2520



L.D. (LIGHT DUTY) CLAMPS

NATURAL & BLACK

SIZE	COLOR	PART NO.
1/8"	Natural	3321
1/8"	Black	3371
3/16"	Natural	3322
3/16"	Black	3372
1/4"	Natural	3323
1/4"	black	3373
5/16"	Natural	3324
5/16"	Black	3374
3/8"	Natural	3325
3/8"	Black	3375
7/16"	Natural	3326
7/16"	Black	3376
1/2"	Natural	3327
1/2"	Black	3377
9/16"	Natural	3328
9/16"	Black	3378
5/8"	Natural	3329
5/8"	Black	3379
11/16"	Natural	3330
11/16"	Black	3380
3/4"	Natural	3331
3/4"	Black	3381
7/8"	Natural	3332
7/8"	Black	3382
1"	Natural	3333
1"	Black	3383

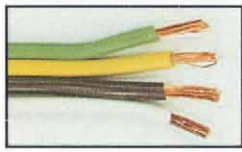

PARALLEL WIRE

	NO. OF CONDUCTORS	LENGTH	PART NO.
	2 12GA.	100'	3812C
	2 12GA.	25'	3812K
	2 14GA.	100'	3814C
	2 14GA.	25'	3814K
	2 16GA.	100'	3816C
	2 16GA.	25'	3816K
	2 18GA.	100'	3818C
	2 18GA.	25'	3818K
	3 14GA.	100'	3914C
	3 14GA.	25'	3914K
	3 16GA.	100'	3916C
	3 16GA.	25'	3916K
	4 14GA.	100'	4014C
	4 14GA.	25'	4014K
	4 16GA.	100'	4016C
	4 16GA.	25'	4016K



12' STRAIGHT TRAILER CABLE ASSEMBLIES



- 4370** 7-14 gauge conductors with plug and spring on both ends.
- 4375** 6-12 gauge 1-10 gauge conductors with plug and spring on both ends.

TRAILER CABLE

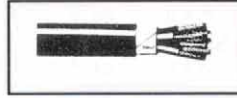
	PART NO.	SIZE
	4378-2C	4-14GA. 2-10GA.
	4380-2C	1-12GA. 6-12GA. 1-10GA.
	4382-2C	4-12GA.
	4384-2C	7-14GA.
	4385-2C	6-14GA.
	4386-2C	4-14GA.
	4387-2C	6-16GA.
	4388-2C	4-16GA.

All PVC-55° 100' lengths

All sizes available in longer lengths upon request.

2-CONDUCTOR SPEAKER WIRE



PART NO.	FEET PER ROLL	SIZE
4050-9C	100'	18GA.
4050-9P	20'	18GA.

BATTERY CABLE

FLEXIBLE ROPE STRANDED BATTERY TO STARTER CABLE; MANUFACTURED TO SAE SPECIFICATIONS.

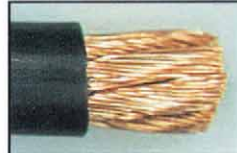
	PART NO.	FEET PER ROLL	SIZE
	4396-2C	100'	4/0GA.
	4396-2K	25'	4/0GA.
	4397-2C	100'	3/0GA.
	4397-2K	25'	3/0GA.
	4398-2C	100'	2/0GA.
	4398-2K	25'	2/0GA.
	4398-4C	100'	2/0GA.
	4398-4K	25'	2/0GA.
	4399-2C	100'	1/0GA.
	4399-2K	25'	1/0GA.
	4399-4C	100'	1/0GA.
	4399-4K	25'	1/0GA.
	4402-2C	100'	2GA.
	4402-2K	25'	2GA.
	4402-4C	100'	2GA.
	4402-4K	25'	2GA.
	4404-2C	100'	4GA.
	4404-2K	25'	4GA.
4404-4C	100'	4GA.	
4404-4K	25'	4GA.	
4406-2C	100'	6GA.	
4406-2K	25'	6GA.	
4406-4C	100'	6GA.	
4406-4K	25'	6GA.	

See pre-made cables, page 23.

MULTI-CONDUCTOR JACKETED CABLE



100' SPOOLS

PART NO.	GAUGE	NO. OF CONDUCTORS
4114-8C	14	4
4116-8C	16	4
4212-8C	12	3
4214-8C	14	3
4216-8C	16	3
4310-8C	10	2
4312-8C	12	2
4314-8C	14	2
4316-8C	16	2
4318-8C	18	2

12' COILED TRAILER CONNECTOR CABLE ASSEMBLIES

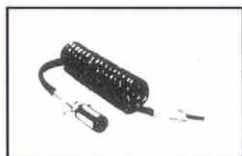

- 4360** 7-14 gauge conductors with plug and spring on both ends.
- 4365** 6-12 gauge 1-10 gauge conductors with plug and spring on both ends.

CABLE COLOR CODE

- 2C = 100' Black 4C = 100' Red
2K = 25' Black 4K = 25' Red

PRIMARY WIRE 50 VOLTS OR LESS

PURE COPPER STRANDED
GPT POLYVINYL INSULATED
AUTOMOTIVE
TRUCKING
INDUSTRIAL
MEETS SAE SPECIFICATIONS
J 1128



PRIMARY WIRE PACKAGES



		PART NO.
8 GAUGE BLACK	100' SPOOL	4408-2C
8 GAUGE RED	100' SPOOL	4408-4C
8 GAUGE WHITE	100' SPOOL	4408-7C
10 GAUGE BLUE	100' SPOOL	4410-1C
10 GAUGE BLACK	100' SPOOL	4410-2C
10 GAUGE GREEN	100' SPOOL	4410-3C
10 GAUGE RED	100' SPOOL	4410-4C
10 GAUGE YELLOW	100' SPOOL	4410-5C
10 GAUGE BROWN	100' SPOOL	4410-6C
10 GAUGE WHITE	100' SPOOL	4410-7C
10 GAUGE GREY	100' SPOOL	4410-8C
10 GAUGE ORANGE	100' SPOOL	4410-10C
10 GAUGE PURPLE	100' SPOOL	4410-11C
12 GAUGE BLUE	100' SPOOL	4412-1C
12 GAUGE BLACK	100' SPOOL	4412-2C
12 GAUGE GREEN	100' SPOOL	4412-3C
12 GAUGE RED	100' SPOOL	4412-4C
12 GAUGE YELLOW	100' SPOOL	4412-5C
12 GAUGE BROWN	100' SPOOL	4412-6C
12 GAUGE WHITE	100' SPOOL	4412-7C
12 GAUGE GREY	100' SPOOL	4412-8C
12 GAUGE ORANGE	100' SPOOL	4412-10C
12 GAUGE PURPLE	100' SPOOL	4412-11C
14 GAUGE BLUE	100' SPOOL	4414-1C
14 GAUGE BLACK	100' SPOOL	4414-2C
14 GAUGE GREEN	100' SPOOL	4414-3C
14 GAUGE RED	100' SPOOL	4414-4C
14 GAUGE YELLOW	100' SPOOL	4414-5C
14 GAUGE BROWN	100' SPOOL	4414-6C
14 GAUGE WHITE	100' SPOOL	4414-7C
14 GAUGE GREY	100' SPOOL	4414-8C
14 GAUGE ORANGE	100' SPOOL	4414-10C
14 GAUGE PURPLE	100' SPOOL	4414-11C
16 GAUGE BLUE	100' SPOOL	4416-1C
16 GAUGE BLACK	100' SPOOL	4416-2C
16 GAUGE GREEN	100' SPOOL	4416-3C
16 GAUGE RED	100' SPOOL	4416-4C
16 GAUGE YELLOW	100' SPOOL	4416-5C
16 GAUGE BROWN	100' SPOOL	4416-6C
16 GAUGE WHITE	100' SPOOL	4416-7C
16 GAUGE GREY	100' SPOOL	4416-8C
16 GAUGE ORANGE	100' SPOOL	4416-10C
16 GAUGE PURPLE	100' SPOOL	4416-11C
18 GAUGE BLUE	100' SPOOL	4418-1C
18 GAUGE BLACK	100' SPOOL	4418-2C
18 GAUGE GREEN	100' SPOOL	4418-3C
18 GAUGE RED	100' SPOOL	4418-4C
18 GAUGE YELLOW	100' SPOOL	4418-5C
18 GAUGE BROWN	100' SPOOL	4418-6C
18 GAUGE WHITE	100' SPOOL	4418-7C
18 GAUGE GREY	100' SPOOL	4418-8C
18 GAUGE ORANGE	100' SPOOL	4418-10C
18 GAUGE PURPLE	100' SPOOL	4418-11C
7MM BLACK		
IGNITION WIRE	100' SPOOL	4427-2C

	FEET PER PACK	PART NO.
8 GAUGE BLACK	8	4408-2P
8 GAUGE RED	8	4408-4P
8 GAUGE WHITE	8	4408-7P
10 GAUGE BLUE	10	4410-1P
10 GAUGE BLACK	10	4410-2P
10 GAUGE GREEN	10	4410-3P
10 GAUGE RED	10	4410-4P
10 GAUGE YELLOW	10	4410-5P
10 GAUGE BROWN	10	4410-6P
10 GAUGE WHITE	10	4410-7P
10 GAUGE GREY	10	4410-8P
10 GAUGE ORANGE	10	4410-10P
10 GAUGE PURPLE	10	4410-11P
12 GAUGE BLUE	15	4412-1P
12 GAUGE BLACK	15	4412-2P
12 GAUGE GREEN	15	4412-3P
12 GAUGE RED	15	4412-4P
12 GAUGE YELLOW	15	4412-5P
12 GAUGE BROWN	15	4412-6P
12 GAUGE WHITE	15	4412-7P
12 GAUGE GREY	15	4412-8P
12 GAUGE ORANGE	15	4412-10P
12 GAUGE PURPLE	15	4412-11P
14 GAUGE BLUE	20	4414-1P
14 GAUGE BLACK	20	4414-2P
14 GAUGE GREEN	20	4414-3P
14 GAUGE RED	20	4414-4P
14 GAUGE YELLOW	20	4414-5P
14 GAUGE BROWN	20	4414-6P
14 GAUGE WHITE	20	4414-7P
14 GAUGE GREY	20	4414-8P
14 GAUGE ORANGE	20	4414-10P
14 GAUGE PURPLE	20	4414-11P
16 GAUGE BLUE	30	4416-1P
16 GAUGE BLACK	30	4416-2P
16 GAUGE GREEN	30	4416-3P
16 GAUGE RED	30	4416-4P
16 GAUGE YELLOW	30	4416-5P
16 GAUGE BROWN	30	4416-6P
16 GAUGE WHITE	30	4416-7P
16 GAUGE GREY	30	4416-8P
16 GAUGE ORANGE	30	4416-10P
16 GAUGE PURPLE	30	4416-11P
18 GAUGE BLUE	40	4418-1P
18 GAUGE BLACK	40	4418-2P
18 GAUGE GREEN	40	4418-3P
18 GAUGE RED	40	4418-4P
18 GAUGE YELLOW	40	4418-5P
18 GAUGE BROWN	40	4418-6P
18 GAUGE WHITE	40	4418-7P
18 GAUGE GREY	40	4418-8P
18 GAUGE ORANGE	40	4418-10P
18 GAUGE PURPLE	40	4418-11P

Primary wire is available on 1000' spools.
Example: Part No. for 1000' of 10 GAUGE RED is 4410-4B

CABLE COLOR CODE

WIRE COLOR	FUNCTION
WHITE	= GROUND
BLACK	= IDENTIFICATION & LICENSE
YELLOW	= LEFTTURN
GREEN	= RIGHTTURN
RED	= STOP
BROWN	= TAIL
BLACK	= CLEARANCE & MARKER
BLUE	= AUXILIARY

NOBLE WIRE & CABLE PART NUMBER COLOR CODE SUFFIX

1 = BLUE	9 = CLEAR
2 = BLACK	10 = ORANGE
3 = GREEN	11 = PURPLE
4 = RED	P = PACKAGED
5 = YELLOW	C = 100'
6 = BROWN	B = 1000'
7 = WHITE	K = 25'
8 = GREY	

CROSSLINK POLYETHYLENE

PRIMARY WIRE, SAE J1128, SXL, RESISTANT TO OIL, GREASE, ACID, AND HIGH TEMPERATURES.

100' SPOOLS	PART NO.
10 GAUGE BLACK	4510-2C
10 GAUGE RED	4510-4C
12 GAUGE BLUE	4512-1C
12 GAUGE BLACK	4512-2C
12 GAUGE GREEN	4512-3C
12 GAUGE RED	4512-4C
12 GAUGE YELLOW	4512-5C
12 GAUGE WHITE	4512-7C
14 GAUGE BLUE	4514-1C
14 GAUGE BLACK	4514-2C
14 GAUGE GREEN	4514-3C
14 GAUGE RED	4514-4C
14 GAUGE YELLOW	4514-5C
14 GAUGE WHITE	4514-7C
16 GAUGE BLUE	4516-1C
16 GAUGE BLACK	4516-2C
16 GAUGE GREEN	4516-3C
16 GAUGE RED	4516-4C
16 GAUGE YELLOW	4516-5C
16 GAUGE WHITE	4516-7C

FUSIBLE LINK WIRE

	GAUGE	PART NO.
	12	4812
	14	4814
	16	4816
	18	4818

Available in 10' and 2 - 9" Pieces.
See price list for details.

SHRINK TUBING 2:1 SHRINK RATIO

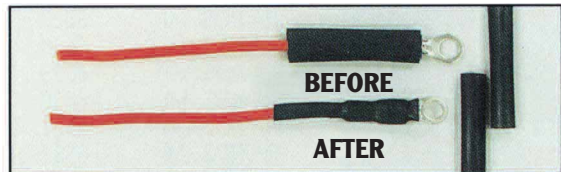

SIZE	FITS	PART NO.
1/8"	30GA.-26GA. WIRE & TERMINALS	5521
3/16"	22GA.-18GA. WIRE & TERMINALS	5522
1/4"	16GA.-10GA. WIRE & TERMINALS	5523
3/8"	8GA.-6GA. WIRE & TERMINALS	5524
1/2"	6GA.-4GA. WIRE & TERMINALS	5525
3/4"	2GA.-3/0GA. WIRE & TERMINALS	5527
1"	4/0GA. & UP WIRE & TERMINALS	5529

Available in 4', 4' & 100'. See price list for details.

HEAVY DUTY 3:1 SHRINK

Heat shrinkable tubing with sealant

	LENGTH COLOR	EXPANDED SIZE I-D	PART NO.
	3" Black	1/4"	5623
	3" Black	3/8"	5624
	6" Black	3/4"	5627
	6" Black	1-1/16"	5629
	6" Red	3/4"	5727
	6" Red	1-1/16"	5729

4600 - Inexpensive cutting, stripping and crimping tool.

4601 - Excellent quality cutting, stripping and crimping tool.

4604 - Ignition terminal and all purpose crimping tool.

4605 - Lug crimping tool. Use in vise or with hammer. 6 gauge through 0000.

4606 - Excellent quality lug crimping tool. For all copper lugs 6 gauge through 0000. Crimpable battery terminals 6 gauge through 00.

4608 - Accommodates terminals 6 gauge through 3/0. Accommodates lugs 8 gauge through 4/0.

4607 - Excellent quality cable cutter. 10 gauge to 000. Copper only, not for steel.

4603 - Open barrel crimping tool. See page 24.

STAINLESS STEEL NUT FOR STUD POST BATTERIES

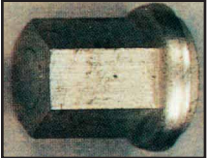
	SIZE	PART NO.
	3/8"	6505

CRIMPABLE BATTERY TERMINALS SIDE MOUNT AND TOP STUD MOUNT WITH RECESSED PAD AND FITS ALL 3/8" BOLTS

	WIRE GAUGE	SIZE	PART NO.
	4GA.	3/8"	6508
	2GA.	3/8"	6509
	1GA.	3/8"	6510
	1/0GA.	3/8"	6511
	2/0GA.	3/8"	6512
	3/0GA.	3/8"	6513
	4/0GA.	3/8"	6514

POST TYPE

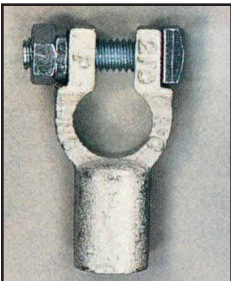
	WIRE GAUGE	PART NO.
	4&6U	6515
	1&2P	6517
	1&2N	6518
	1/0P	6519
	1/0N	6520
	2/0P	6521
	2/0N	6522
	3/0P	6523
	3/0N	6524
	4/0P	6525
	4/0N	6526

ELBOW

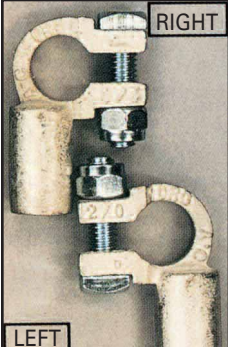
	RA POS. 1/0	6527
	RA NEG. 1/0	6528
	LA POS. 1/0	6529
	LA NEG. 1/0	6530
	RA POS. 2/0	6531
	RA NEG. 2/0	6532
	LA POS. 2/0	6533
	LA NEG. 2/0	6534
	RA POS. 3/0	6535
	RA NEG. 3/0	6536
	LA POS. 3/0	6537
	LA NEG. 3/0	6538

FLAG

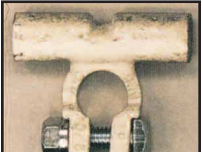
	POS. 1/0	6539
	NEG. 1/0	6540
	POS. 2/0	6541
	NEG. 2/0	6542
	POS. 3/0	6543
	NEG. 3/0	6544

FOR 3/8" STUD POST BATTERIES SOLDER ONLY

	2/0	6552
	3/0	6553

CORROSION DETERRENT TREATED PROTECTORS

	PART NO.
 POST TERMINAL	6570

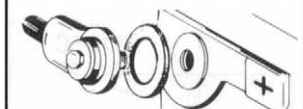
 SIDE TERMINAL	6571
--	------

WING NUT TYPE

	SIZE	PART NO.
	3/8"	6572
	5/16"	6573

BATTERY HOLD DOWN BOLTS

	6-1/2"	6581
	9-1/2"	6585

CHARGING POSTS FOR SIDE TERMINALS

	POS. 3/8"	6607
	NEG. 3/8"	6608



CONVERSION TERM.

	POS. 3/8"	6609
	NEG. 3/8"	6610

BATTERY POST SHIMS

	6611
---	------

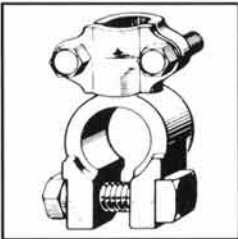
BATTERY TERMINALS

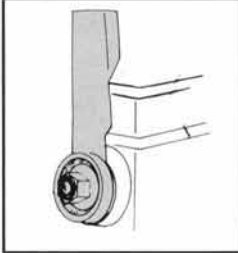
		PART NO.
	UNIVERSAL HEAVY DUTY LEAD	6612
	WING NUT	6614
	SIDE TERMINAL	6622
	SIDE TERMINAL CONVERSION	6623

BRASS SOLDER ONLY

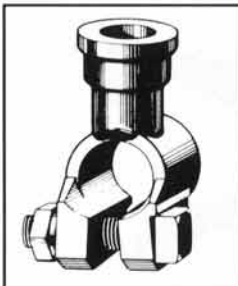
	WIRE GAUGE	PART NO.
	4&6U	6616
	2U	6617
	1/0U	6618
	POS. 2/0-3/0	6619
	NEG. 2/0-3/0	6620



SPLIT BARREL BRASS

	SIZE	PART NO.
	POS. 1/0	6625
	NEG. 1/0	6626
	POS. 2/0-3/0	6627
	NEG. 2/0-3/0	6628

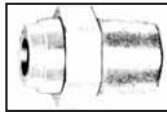

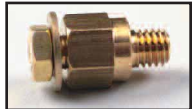

CHARGING POST FOR STUD POST BATTERY

	SIZE	PART NO.
	3/8"	6624

BATTERY TERMINAL NUTS & BOLTS

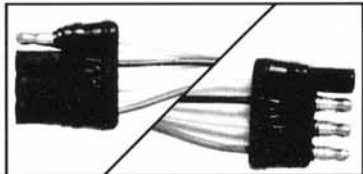
	SIZE	PART NO.
	5/16"x1-3/8"	6630
	3/8"	6629
	3/8"	6631

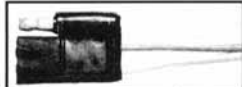
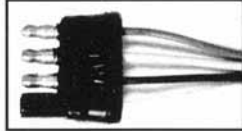
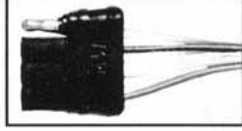
TRAILER CONNECTORS 16 GAUGE WIRE

		LENGTH	PART NO.
	UNIVERSAL 4-WIRE	12"	6632
	2-WIRE	Wire colors opposite 6634	12" 12" 6634 6635
	3-WIRE MALE	12"	6639
	3-WIRE FEMALE	12"	6640
	4-WIRE MALE	12"	6645
	4-WIRE FEMALE	12" 48" 60"	6646 6648 6650
	4-WIRE SQUARE	MALE FEMALE FEMALE	12" 12" 48" 6651 6654 6655
	6-WIRE	MALE FEMALE	12" 12" 6665 6666

METAL TRAILER CONNECTORS

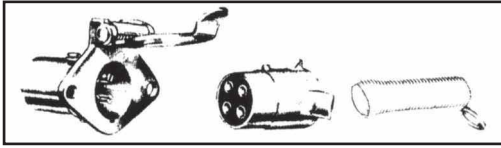

	PART NO.
--	----------

AUTO, BOAT & RV	4-POLE Socket	6670
	4-POLE Plug	6671
	6-POLE Socket	6672
	6-POLE Plug	6673
	7-POLE Socket	6676
HD TRUCK & TRAILER	7-POLE Plug	6677
	Spring for 7-Pole Plug	6678
	MOUNTING BRACKET	6680



ADAPTER PLUG 7-Way to 4-Way	6681
--------------------------------	------



7-WAY RV PLUG	6683
---------------	------



7-WAY RV SOCKET	6684
-----------------	------

BATTERY TERMINAL TOOL



BRUSH TYPE	6701
------------	------

CHASSIS CLIPS

	SIZE	PART NO.
	3/16"	7701
	1/4"	7702
	3/8"	7703

VACUUM CAPS

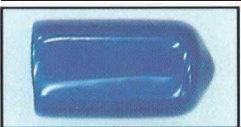

	COLOR	SIZE	PART NO.
	BLACK	1/8"	7721
	WHITE	3/16"	7722
	RED	1/4"	7723
	BLUE	5/16"	7724
	YELLOW	3/8"	7725
	GREY	1/2"	7726

Available in mini packs and regular packs.

7MM IGNITION TERMINALS

PART NO.		PART NO.
8001		8005
8002		8006
8003		8007
8004		8008

ALLIGATOR CLIPS

	SIZE	PART NO.
	MINI CLIP 1-1/4" long. Jaws open 3/16"	1-1/4" 8009
	2" CLIP	2" 8010
	PAIRS w/ins. 1 red, 1 black	2" 8036

3 OZ. PACK OF ASSORTED TERMINALS & CONNECTORS

8011

TEST CLIPS

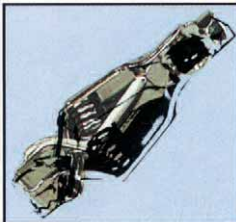
	SIZE	PART NO.
	5 AMP	8012
	10 AMP	8018
	24 AMP	8022
	50 AMP	8026





UTILITY CLIPS, 3" LONG

	SIZE	PART NO.
	50 AMP 3" 1 red, 1 black, pair	8040

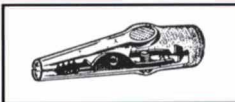

BOOSTER CABLE CLAMP 400 AMP PAIRS, 1 RED, 1 BLACK

	8045
--	------

**TEST CLIPS
WITH RED & BLACK INS. BOOT, PAIRS**

		PART NO.
	1 red, 1 black w/8009 clip	8109
	1 red, 1 black w/8010 clip	8110
	1 red, 1 black w/8012 clip	8112
	1 red, 1 black w/8036 clip	8136

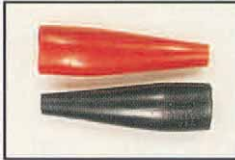
**INSULATOR BOOTS ONLY
PAIRS, 1/2 RED, 1/2 BLACK**

		PART NO.
	FITS 8009	8129
	FITS 8010 & 8036	8130
	FITS 8012	8132



IN-LINE FUSE HOLDERS

		PART NO.
	12 ON A CARD 12GA. WIRE	6-20 AMP 6-30 AMP 1 in Pack 20 AMP
		8215 8215-20 8215-30
	10GA. WIRE	1 in Pack 30 AMP
		8216-30

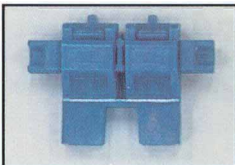
SELF-STRIPPING, ATO/ATC TYPE FUSE HOLDERS

	WIRE GAUGE	PART NO.
	18-14	8217

MOLDED ATO/ATC TYPE FUSE HOLDERS

		PART NO.
	12GA. mini 12GA. ATO/ATC 6GA. maxi	8219 8221 8229
	16GA. 12GA.	8231 8235





**PANEL MOUNT FUSE HOLDER
FOR GLASS FUSE, 2 through 20 AMP**

	SIZE	PART NO.
	1/4"x1-1/4"	8240



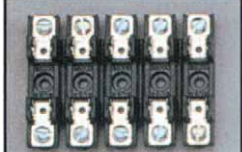

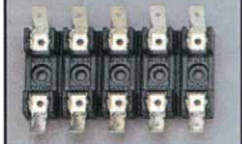

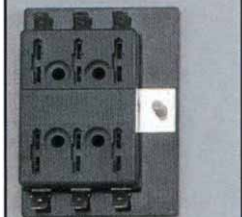
**UNIVERSAL FUSE HOLDER
18GA. thru 12GA.
JUST STRIP INSERT CRIMP**

	SIZE	PART NO.
	1/4"x7/8" thru 1-1/4"	8246

**FUSE BLOCKS
USE 1/4" X 1-1/4"**

		PART NO.
	30A. 	8260-05
	20A. 	8265-05
	USE ATC/ATO TYPE 30 AMP each total max 160	8270-06

TERMINAL BLOCK

	20A. 	8275-06
	30A. 	8280-04
	75A. 	8285-03

SENDING UNIT OR SNAP PLUG 90° RECEPTACLE

	SIZE	PART NO.
	.157	8526

LIGHTING ACCESSORIES

	PART NO.
--	----------

SINGLE CONTACT PIGTAIL

	8601
---	------

DOUBLE CONTACT PIGTAIL

	8602
---	------

UNIVERSAL LIGHT SOCKET

	SINGLE CONTACT	8606
	DOUBLE CONTACT	8607

SEALED BEAM HEADLAMP CONNECTOR

	3-WIRE Leads	8610
---	--------------	------



ACCESSORY POWER SOURCE PLUG

Just connect the pigtails from your razor, trouble light or other accessory and plug into the cigarette lighter socket. 8 amp max.



	PART NO.
--	----------

	8615
---	------

SWITCHES – UNIVERSAL 6-12 VOLT SYSTEMS

	PUSH-PULL ON-OFF Amps: 35 at 6V, 20 at 12V	8631
	TOGGLE ON-OFF Amps: 35 at 6V, 20 at 12V	8641
	MOMENTARY, NORMALLY OFF Amps: 60 at 12V, 40 at 24V	8661

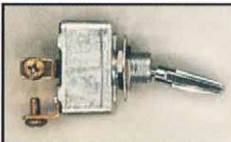
SWITCHES – UNIVERSAL (CONT.)

		PART NO.
	DECORATOR TOGGLE ON-OFF DECORATOR TOGGLE ON-OFF-ON Amps: 35 to 6V or 12V	8671
	DUCK BILL TOGGLE ON-OFF Amps: 16 to 12V	8681

HEAVY DUTY TEST LEADS

	SIZE	PART NO.
	3'	8703
	6'	8706
	12'	8712



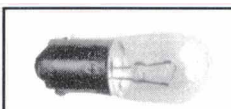

CIRCUIT TESTER

		PART NO.
	6 & 12 VOLT	8801

BULB FOR 8801 TESTER

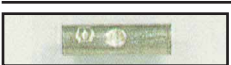
		PART NO.
	6 & 12 VOLT	8802
	18-24-36 VOLT	8803

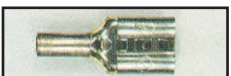
HIGH TEMPERATURE TERMINALS NICKEL PLATED STEEL ALLOY 900°F

	AWG	STUD SIZE	PART NO.
	22-18		H-11
	16-14		H-12
	12-10		H-13
	16-14	6	H-221
	16-14	10	H-223
	12-10	10	H-233
	16-14	.250	H-521
	16-14	.250	H-522
	12-10	.250	H-532
	16-14	.250	H-796

CONNECTORS & TERMINALS WITH HEAT SHRINK SEAL

BUTT CONNECTORS

	AWG	PART NO.
	22-18	SS-11*
	16-14	SS-12*
	12-10	SS-13*

MALE QUICK CONNECTS

	AWG	STUD SIZE	PART NO.
	22-18	.250	SS-511*
	16-14	.250	SS-521*
	12-10	.250	SS-531*

RING TERMINALS

	AWG	STUD SIZE	PART NO.
	22-18	6	SS-211
	22-18	8	SS-212
	22-18	10	SS-213*
	22-18	1/4	SS-214
	16-14	6	SS-221
	16-14	8	SS-222
	16-14	10	SS-223*
	16-14	1/4	SS-224*
	16-14	5/16	SS-225
	16-14	3/8	SS-226
	12-10	8	SS-232
	12-10	10	SS-233*
	12-10	1/4	SS-234*
	12-10	5/16	SS-235*
	12-10	3/8	SS-236*
	12-10	1/2	SS-237

FEMALE QUICK CONNECTS

	AWG	STUD SIZE	PART NO.
	22-18	.250	SS-512
	16-14	.250	SS-522
	12-10	.250	SS-532

FULLY INSULATED MALE QUICK CONNECTS

	AWG	STUD SIZE	PART NO.
	22-18	.250	SS-515
	16-14	.250	SS-525
	12-10	.250	SS-535

SPADE TERMINALS

	AWG	STUD SIZE	PART NO.
	22-18	6	SS-311
	22-18	8	SS-312
	22-18	10	SS-313
	16-14	6	SS-321
	16-14	8	SS-322
	16-14	10	SS-323
	12-10	8	SS-332
	12-10	10	SS-333

FULLY INSULATED FEMALE QUICK CONNECTS

	AWG	STUD SIZE	PART NO.
	22-18	.250	SS-516*
	16-14	.250	SS-526*
	12-10	.250	SS-536*

SPRING SPADE

	AWG	STUD SIZE	PART NO.
	22-18	6	SS-371
	22-18	8	SS-372
	22-18	10	SS-373*
	16-14	6	SS-381
	16-14	8	SS-382
	16-14	10	SS-383*
	12-10	6	SS-391
	12-10	8	SS-392
	12-10	10	SS-393*

UNDERWATER SPLICE KITS

Three 3" pieces of heavy duty waterproof heat shrink tube and 3 brazed Barrel butt connectors with small hole for solder.

	AWG	PART NO.
	16-14	W-200
	12-10	W-300
	8	W-400
	6	W-500
	4	W-600
	2	W-700
	1/0	W-800
2/0	W-900	

Part numbers on this page with an asterisk (*) are available in the crimp, solder, and shrink CSS series. Example: Part #SS-11" is also available in Css-11. And you will find them in the price list.

NOBLE

WIRE & TERMINAL CORP.

GLASS FUSES AGC 1/4" x 1-1/4"

	PART NO.	AMP
	8151-03	3
	8151-05	5
	8151-10	10
	8151-15	15
	8151-20	20
	8151-25	25
	8151-30	30

BLADE FUSES ATO/ATC TYPE

	PART NO.	AMP
	8152-03	3
	8152-04	4
	8152-05	5
	8152-07	7.5
	8152-10	10
	8152-15	15
	8152-20	20
	8152-25	25
	8152-30	30

MINI FUSES

	PART NO.	AMP
	8153-04	4
	8153-05	5
	8153-07	7.5
	8153-10	10
	8153-15	15
	8153-20	20
	8153-25	25
	8153-30	30

MAXI FUSES

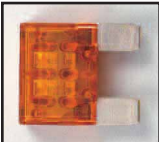
	PART NO.	AMP
	8154-30	30
	8154-40	40

TESTER PULLER

	PART NO.
	8160

TRI- PULLER

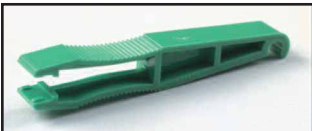
	PART NO.
	8163

MAXI- PULLER

	PART NO.
	8165

BATTERY CABLES

	PART NO.	LENGTH
	6710-2	10"
	6714-2	15"
	6719-2	20"
	6723-2	25"
	6731-2	32"
	6738-2	38"
	6748-2	48"
	6758-2	58"
	6772-2	72"

	PART NO.	LENGTH
	6781-4	18"
	6784-4	32"
	6787-4	49"

	PART NO.	LENGTH
	6793-2	30"
	6794-2	40"
	6795-2	50"

BRAZED BARREL LUGS

	WIRE SIZE	STUD SIZE	PART NO.
	8GA.	10	BU-911
	8GA.	1/4"	BU-912
	8GA.	5/16"	BU-913
	8GA.	3/8"	BU-914
	8GA.	1/2"	BU-915
	6GA.	10	BU-917
	6GA.	1/4"	BU-918
	6GA.	5/16"	BU-919
	6GA.	3/8"	BU-920
	6GA.	1/2"	BU-921
	4GA.	10	BU-923
	4GA.	1/4"	BU-924
	4GA.	5/16"	BU-925
	4GA.	3/8"	BU-926
	4GA.	1/2"	BU-927
	2GA.	10	BU-929
	2GA.	1/4"	BU-930
	2GA.	5/16"	BU-931
	2GA.	3/8"	BU-932
	2GA.	1/2"	BU-933
	1/0	1/4"	BU-935
	1/0	5/16"	BU-936
	1/0	3/8"	BU-937
	1/0	1/2"	BU-938
	2/0	1/4"	BU-940
	2/0	5/16"	BU-941
	2/0	3/8"	BU-942
	2/0	1/2"	BU-943
	3/0	1/4"	BU-945
	3/0	5/16"	BU-946
	3/0	3/8"	BU-947
	3/0	1/2"	BU-948
	4/0	1/4"	BU-951
	4/0	5/16"	BU-952
	4/0	3/8"	BU-953
	4/0	1/2"	BU-954



Male Terminal
8307 19 (20-18)
8305 15 (16-14)

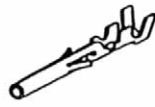

Female Terminal
8308 19 (20-18)
8306 15 (16-14)



Cable Seal
8316 GRN (20-16)
8315 GRA (14 ga.)



Plug
8319



ONE CONDUCTOR
8321 Tower



TWO CONDUCTOR
8323 Tower



THREE CONDUCTOR
8325 Tower



ONE CONDUCTOR
8322 Shroud



TWO CONDUCTOR
8324 Shroud

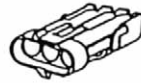

THREE CONDUCTOR
8326 Shroud

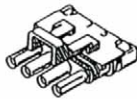

FOUR CONDUCTOR
8327 Tower

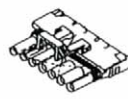

SIX CONDUCTOR
8333 Tower

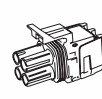

FOUR CONDUCTOR SQUARE
8329 Tower



FOUR CONDUCTOR
8328 Shroud



SIX CONDUCTOR
8334 Shroud

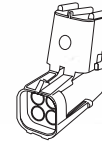

FOUR CONDUCTOR SQUARE
8330 Shroud

ASSORTMENT 9750
(W.P. Series)

10" x 48" PANEL

O.B. Crimping Tool – 1 each:
4603

P.T. Extract Tool – 2 each:
8300

Fuseholder – 2 each:
8250

W.P. Plug
8319

W.P. Pins – 2 each:
8305 8306

8307 8308

Seals – 2 each:
8315 8316

Towers and Shrouds – 2 each:

8321	8322	8323	8324
8325	8326	8327	8328
8329	8330	8333	8334

Panel #9750 W.P. Series for automotive and trucking consists of 1 open barrel crimping tool and 2 pin terminal extractor tools. 2 sealed ATC/ATO fuseholders male and female pins for 16-14 gauge and male and female pins for 20-18 gauge. 2 each seals for both 16 and 18 gauge. There are 2 each of six numbers of towers and 2 each of six numbers of shrouds ranging from 1 conductor to 6 conductor.

OPEN BARREL TERMINAL CRIMP TOOL

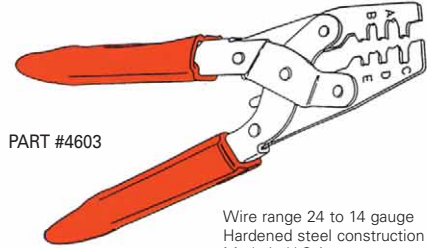

PART #4603

Wire range 24 to 14 gauge
Hardened steel construction
Made in U.S.A.

Duplicates factory crimps on non-insulated pin, socket, spring, box, ring, spade and Quick Connect terminals.

TERMINAL EXTRACTOR TOOL



PART #8300
WILL RELEASE TERMINALS FROM CONNECTOR HOUSING BY DEPRESSING RETENTION BARBS

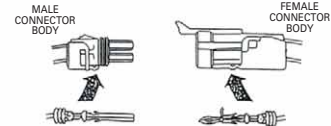

Crimped terminals with seals in place and a typical set of connector shells.

ENVIRONMENTALLY SEALED AUTOFUSE HOLDER

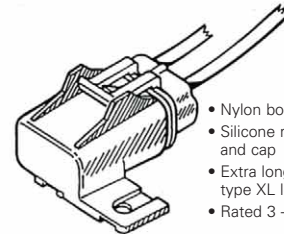

- Nylon body with latching cap
- Silicone rubber seals at wires and cap
- Extra long (9") 12 gauge type XL leads
- Rated 3 - 30 Amps

PART #8250

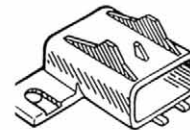

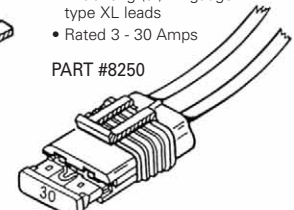

Temperature range
40 to 260 F

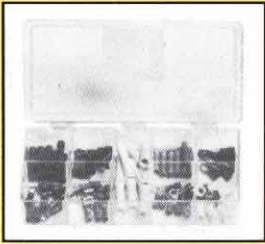

fuse shown for illustration purposes only
FUSES NOT SUPPLIED

KITS

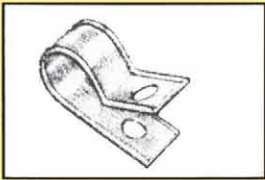
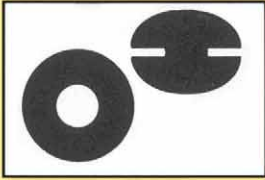
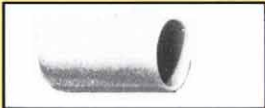
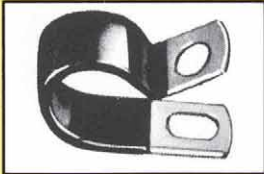
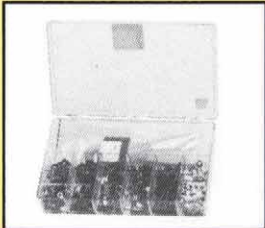
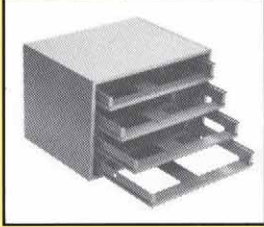
	PART NO.		PART NO.		
	1-T	TERMINAL KIT 72 assorted pieces	TERMINAL KIT 414 terminals & crimping tool	4-T	
			EMPTY KIT	4-TE	
					13-15/16"x9-1/4"x2"
	1-C	CLAMP KIT 72 L.D. Clamps 1/8" thru 9/16"	CLAMP KIT 364 L.D. Clamps 1/8" thru 1"	4-C	
					Kit size 13-15/16"x9-1/4"x2"
					Kit size 7"x3-1/2"x1-1/4"
	1-G	GROMMET KIT 72 grommets 1/4" thru 21/32"	GROMMET KIT 400 grommets 1/4" thru 1"	4-G	
					Kit size 13-15/16"x9-1/4"x2"
					Kit size 7"x3-1/2"x1-1/4"
			EMPTY KIT	4-E	
					Kit size 13-15/16"x9-1/4"x2"
			EMPTY KIT	4-E	
					Kit size 13-15/16"x9-1/4"x2"
	1-V	VACUUM CAP KIT 100 vacuum caps 1/8" thru 1/2"	CLAMP KIT 94 vinyl insulated metal clamps 1/4" thru 1-1/2"	4-I	
					13-15/16"x9-1/4"x2"
					Kit size 7"x3-1/2"x1-1/4"
	3-T	TERMINAL KIT 240 assorted terminals & crimping tool	RACK ONLY Fits all 4-series kits	4SR4	
					Kit size 11"x6-1/2"x1-3/4"
					Kit size 11"x6-1/2"x1-3/4"
			EMPTY KIT	3-E	

KITS

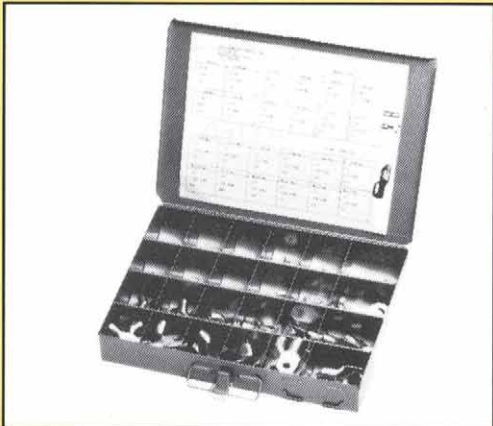

13-5/16"x9-1/4"x2"

4L-1 KIT
5 pieces each of our part numbers 910 through 937

4L-2 KIT
5 pieces each of our part numbers 938 through 954

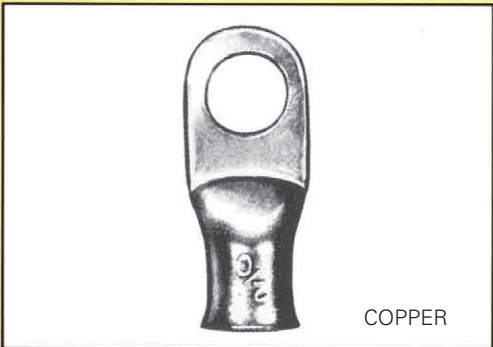

COPPER

4L-3 KIT
5 pieces each of these part numbers:
910 911 912 913 914 915
916 917 918 919 920 921
924 925 926 930 931 932
936 937 938 941 942 943



18"x12"x3"

5-T KIT
1200 terminals

5-E KIT
Empty

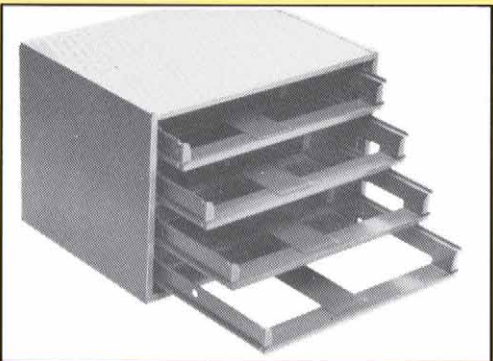

5SR4
Rack to hold 4 #5 kits

PACKAGES

WE FAVOR THE CLEAR PACKAGE SO THE CUSTOMER MAY SEE THE PART WITHOUT DESTROYING THE PACKAGE.



Mini-Pack

Sell a package for as little as it costs you to sell one terminal. All the Mini-Packs sell for the same price. A convenience for you, a service for customers.

Thrifty Pack

A little larger than the Mini-Pack with more pieces. Very popular with the grommets and L.D. clamps.

Half Pack

Each package contains 1/2 as many pieces as the Regular Pack. Available in part numbers 11 through 734 only.

Regular Pack

Check the price list for the number of pieces per pack. Use the part number with no suffix.



Bulk Pack

Check the price list for the number of pieces per pack. Add (B) after the part number. Special packaging may be arranged on large orders.

PACKAGES

NOBLE PACKAGING HAS PROVEN TO BE EXCELLENT IN THE MARKETPLACE. FOR DETAILS OF NUMBER OF PIECES PER PACK IN ALL SIZE PACKAGES, SEE PRICE LIST.

Copper Lugs

Available 8 gauge through 0000.



L.D. (Light Duty) Clamps

Available 1/8" through 1".



Nylon Tie-Wrap

Natural and black, available 3" 18 lbs. through 32" 175 lbs. tensile strength.



Packaged Primary Wire

Available 8 gauge through 18 gauge. Also 2 conductor speaker wire.



Trailer Connectors

16 gauge wire.



Vinyl Insulated Clamps

Available 1/4" through 3".



Shrink Tube

4" pieces, 1/8" through 1" fits 30 gauge through 0000.



100' Spools Primary Wire

8 gauge through 18 gauge.



1,000' Spools Available

See price list.

POINT OF PURCHASE DISPLAYS

9711

9712

9713

9714

9731



9716

9717

9718

9719

9735



NOBLE PANELS ARE 17" BY 48". ALLOW 1" MINIMUM BETWEEN EACH PANEL WHEN MOUNTING ON YOUR WALL OR FIXTURES. ALLOW 2" BETWEEN EACH PANEL WITH 100' SPOOLS.

POINT OF PURCHASE DISPLAYS

THIS 9980 TOPPER COMPLEMENTS THE 9915,
THE 9910 AND THE 9990.



THE STORE THAT SERVES A LOT OF AUTOMOTIVE AND A LOT OF
HEAVY-DUTY TRUCKS AND TRAILERS OR LARGE EQUIPMENT
WILL NEED THESE FOUR PANELS ALONG WITH THE 9910.

POINT OF PURCHASE DISPLAYS



THE 9910

WHEN THERE IS ROOM FOR ONLY ONE DISPLAY, THIS 9910 WITH A 9980 TOPPER SHOWN ON PAGE 30 IS A GREAT CHOICE.

POINT OF PURCHASE DISPLAYS



Panel III

Panel IV

THE 9910
THE SELECTION IS THE RESULT OF NOBLE'S
CUSTOMERS LISTENING TO THEIR CUSTOMERS.

POINT OF PURCHASE DISPLAYS



9982

MIXES WELL WITH 9711, 9712,
9713 AND 9714

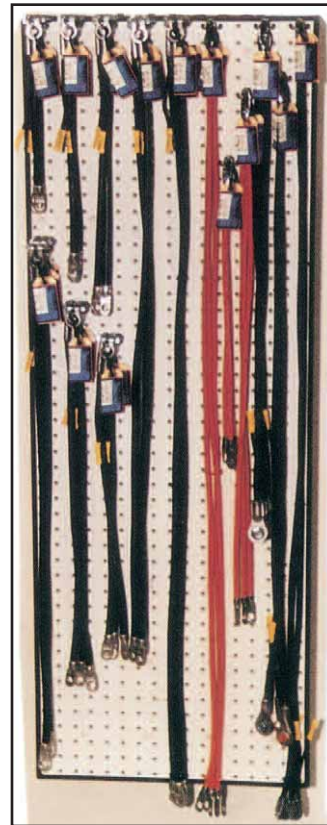

9760

**BATTERY CABLE
ASSORTMENT**



9758



9755



9750



9736

**UNINSULATED
TERMINALS**

**9981
TOPPER**
Side I



Side I

Side II

**9981
TOPPER**
Side II



Side III

Side IV

THE 9915

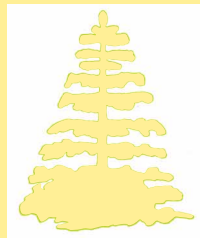

NOBLE[®]
WIRE & TERMINAL CORP.

1620 32ND STREET • SPRINGFIELD, OREGON 97478-5529
PHONE 541-744-0630 • FAX 541-744-1173
PHONE 1-800-547-4711 • FAX 1-800-874-6602
www.noblewire.com

MALE TAB CHART	
	WIDTH INCHES
	.110
	.187
	.250
	.312
	.375

STUD SIZE CHART	
	DIA. INCHES
	#4-.119
	#6-.148
	#8-.178
	#10-.198
	1/4"-.265
	5/16"-.326
	3/8"-.390
	12"-.518

- A Complete Wiring Center
- Terminals
- Wire
- Tie Wraps
- Grommets
- Clamps
- Crimping Tools
- Kits
- Battery Terminals
- Lugs
- Shrink Tubing
- Test Clips
- Finest Quality American Made
- A Package The Right Size For Every Customer
- An Assortment The Right Size For Every Store
- In Excess of 99% Orderfill...Today
- This Small Space Works For You All The Time
- Your Customers Can Find Them
- Your Counter People Can Find Them

NOBLE[®]
WIRE & TERMINAL CORP.
 ■ SPRINGFIELD, OREGON
 ■ CORTLAND, OHIO